

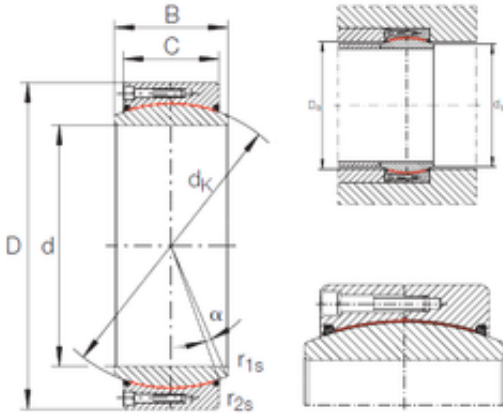

BEARING Driveshaft USA CORP.

500 mm x 670 mm x 230 mm INA GE 500 DW-2RS2 plain bearings

Bearing No. GE 500 DW-2RS2



GE 500 DW-2RS2 Bearing 2D drawings and 3D CAD models

Size	500x670x230 mm
Bore Diameter	500 mm
Outer Diameter	670 mm
Width	230 mm
d	500 mm
D	670 mm
B	230 mm
C	195 mm
dk	585 mm
r1 min.	2 mm
r2 min.	5 mm
da max	537,8 mm
Da min	557 mm
Angle	3,6 °
Weight	243 Kg
Basic dynamic load rating (C)	29,3 kN